



Coriolis mass flow sensors

TM
TMU
TM-SH

Supplementary Operating Manual for explosion-proof flow-sensors



Please read the instructions carefully and store them in a safe place

CONTENTS

INTRODUCTION.....	3
I. Shipping and storage; product inspection.....	3
II. Warranty.....	3
III. Validity of this operating manual.....	3
1. STEPS PRIOR TO OPERATION.....	4
1.1 Installation, mounting, commissioning and maintenance.....	4
1.2 Hazard warnings.....	5
1.3 Proper use of the device.....	6
2. IDENTIFICATION.....	6
2.1 Version / date.....	6
3. CORIOLIS MASS FLOW METERS.....	7
3.1 Description of the TM, TMU, and TM-SH sensors.....	7
3.2 Device identification.....	7
3.2.1 TM/TMU/TM-SH rating plate.....	7
3.3 Mounting.....	8
3.3.1 Thermally insulated sensor.....	8
3.3.2 Heated sensor.....	8
3.3.3 Connection remote sensor – transmitter.....	8
3.4 EC Type-Examination Certificate for the sensors type TM, TMU and TM-SH.....	9
3.5 Electrical Parameters.....	10
3.5.1 Exciter circuit (terminals 8 and 9).....	10
3.5.2 Sensor circuits (terminals 1 – 2 and 3 – 4).....	10
3.5.3 Temperature sensor circuits (terminals 5 to 7).....	10
3.5.4 Ambient temperature range Ta.....	11
3.6 Connecting the sensor to a transmitter.....	12
3.6.1 Connecting cables.....	12
4. INSTALLATION AND COMMISSIONING.....	13
4.1 Mounting.....	13
4.1.1 General conditions for safe operation.....	13
4.1.2 Requirements for installation in all environments.....	13
4.2 Ex relevant screw and bolt torques.....	14
5. MAINTENANCE AND REPAIR WORK.....	15
5.1 Definition of terms according to IEC 60079-17:.....	15
5.2 Fault elimination.....	16
5.3 Disposal.....	16
6. RELEVANT STANDARDS FOR HAZARDOUS LOCATIONS.....	17
6.1 (CSA, North America).....	17
6.2 ATEX (Europe) / IECEx.....	17
7. EU DECLARATION OF CONFORMITY.....	18

Introduction

I. Shipping and storage; product inspection

The device is to be safeguarded against moisture, dirt, impact and damage.

Product inspection

Upon receipt of the product, the consignment should be checked for completeness. The data of the device have to be compared with the packing slip and the order documents

Notify us of any shipping damage immediately upon receipt of the product. Any damage claim received at a later time will not be honored.

II. Warranty

Your flow sensor was manufactured in accordance with the highest quality standards and was thoroughly tested prior to shipment. However, in the event any problem arises with your device, we will be happy to resolve the problem for you as quickly as possible under the terms of the warranty which can be found in the terms and conditions of delivery. Your warranty will only be honored if the device was installed and operated in accordance with the instructions for your device. Any mounting, commissioning and/or maintenance work is to be carried out by qualified and authorized technicians only.

III. Validity of this operating manual



The present instructions apply to explosion-proof Coriolis flow sensors of the TM/TMU and TM-SH series, **as of year of construction March 2021 or later.**

These instructions are supplementary operating manual for non-explosion proof Coriolis flow sensors. If you do not have a copy of the latter instructions, please request one from Heinrichs Messtechnik GmbH or download the instructions from our website.

The instructions herein pertain primarily to explosion proof Coriolis flow sensors for use in conjunction with an explosion proof certified transmitter. The technical data in the mounting and operating instructions for non-explosion proof Coriolis flow sensors still apply insofar as the present instructions do not replace them or exclude their application.

The transmitter used in conjunction with a TM/TMU or TM-SH sensor must be listed for use in Canada and/or USA depending on its area of installation. The manufacturer's installation drawings shall be followed when installing this equipment.

Repairs and hazardous materials

It is important that you do the following before shipping your flow sensor to Heinrichs Messtechnik GmbH for repair:

- Enclose a description of the problem with your device. Describe in as much detail as possible the application and the physical and chemical properties of the fluid.
- Remove any residues from the device and be sure to clean the seal grooves and recesses thoroughly. This is particularly important if the fluid is corrosive, toxic, carcinogenic, radioactive or otherwise hazardous.

The operator is liable for any substance removal or personal damage costs arising from inadequate cleaning of a device that is sent for repair.

1. Steps prior to operation

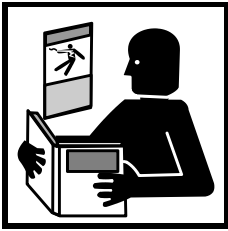

Prior to installation and operation, it is essential that the operator familiarizes himself with all of the instructions and information contained in the manual for non-explosion proof Coriolis flow meters as well as the present instructions. If any part of either manual is missing, contact Heinrichs Messtechnik GmbH to request a new manual. These manuals can also be downloaded from our website.

The TM, TMU and TM-SH sensors described herein are only to be used to measure liquid and gas mass and volume flow, as well as density and temperature, in conjunction with a transmitter certified for use in the area and country of operation, and compatible with the parameters of the sensor.

1.1 Installation, mounting, commissioning and maintenance

Installation, mounting, commissioning and maintenance are to be performed by a technician trained to work with explosion-proof devices, or by a Heinrichs Messtechnik service technician.



Warning:

Any safety relevant maintenance or repairs in terms of explosion-protection is to be carried out by the manufacturer, an authorized Heinrichs Messtechnik GmbH service center or under the supervision of an expert in explosion proof devices.

Heinrichs Messtechnik GmbH accepts no liability for any loss or damage of any kind arising from improper operation of any product, improper handling or use of any replacement part, or from external electrical or mechanical effects, overvoltage or lightning. Any such improper operation, use or handling shall automatically invalidate the warranty for the product concerned.

In the event a problem arises with your device, or if you need assistance in diagnosing a problem with your device, please contact us at one of the following numbers to arrange to have your device repaired:



+49 (0)221 49708-0



+49 (0)221 49708-178

Company:

Heinrichs Messtechnik GmbH
HM-EE (R&D Department)
Robert-Perthel-Strasse 9
D-50739 Cologne
Germany

1.2 Hazard warnings

The purpose of the hazard warnings listed below is to ensure that device operators and maintenance personnel are not injured and that the flow meter and any devices connected to it are not damaged.

The safety advisories and hazard warnings in the present document that aim to avoid placing operators and maintenance personnel at risk and to avoid material damage are prioritized using the terms listed below, which are defined as follows in regard to the instructions herein and the advisories pertaining to the device itself.

Warning



means that failure to take the prescribed precautions **could result** in injury, substantial material damage or even death. Always comply to these warnings and proceed with caution.

Caution



means that failure to take the prescribed precaution **could result** in material damage or destruction of the device. We advise always to abide to these instructions!

Note



means that the accompanying text contains important information about the product, handling the product or about a section of the documentation that is of particular importance.

1.3 Proper use of the device

The Coriolis Mass Flow Sensor is intended for the sole use of direct and continuous mass flow measurement of liquids and gases.

To ensure safety for people and the environment adhere to the installation and operational instructions and warning in this manual



Warning

The operator is responsible for ensuring that the material used in the sensor and housing are suitable and that such material meets the requirements for the process medium and the ambient site conditions.

The manufacturer accepts no responsibility for the selection of unsuitable materials.



Caution

To ensure the device performs correctly and safely, it must be shipped, stored, set up, mounted, operated and maintained correctly.

2. Identification

Manufacturer	Heinrichs Messtechnik GmbH Robert-Perthel-Straße 9 D-50739 Köln Phone: +49 221 49708-0 Fax: +49 221 49708-178 Internet: http://www.heinrichs.eu E-mail: info@heinrichs.eu
Product type	Mass flow meter for liquid and gaseous products
Product name	TM/TMU/TM-SH Coriolis mass flow sensors
Products classes:	(North America)
CLASS 2258 04	PROCESS CONTROL EQUIPMENT – Intrinsically Safe, Entity – For Hazardous Locations
CLASS 2258 84	PROCESS CONTROL EQUIPMENT – Intrinsically Safe, Entity – For Hazardous Locations – Certified to US Standards

2.1 Version / date

Version: TMX-EX_NA_BA_21.01_DRAFT.DOC

Dated: 2021-03-27 (yyyy.mm.dd)

3. Coriolis mass flow meters

3.1 Description of the TM, TMU, and TM-SH sensors

The TM* series of sensors have an "Intrinsic safety" type of protection which is equipped with the following four independent potential-free circuits:

- Excitation circuit
- Sensor circuit 1
- Sensor circuit 2
- Temperature sensor circuit (RTD)

All circuits within the sensor possess a safe separation.

When remote mounted, the transmitter should be connected to the sensor using a dedicated cable specially designed for this purpose. Such a cable can be purchased from Heinrichs Messtechnik during your order process.

Although the appearance of the standard and explosion-proof transmitters are often identical and their rating plates contain similar information, **under no circumstances** should a standard (non-explosion proof) transmitter be connected to an explosion-proof sensor!

3.2 Device identification

The rating plates on Heinrichs Messtechnik flow meters that are suitable for use in potentially explosive atmospheres are labeled accordingly. Since the sensor and transmitter have different ratings, each device has its own rating plate.

3.2.1 TM/TMU/TM-SH rating plate

The rating plate contains all the information necessary to identify the sensor, and for determining its suitability for a potential explosive atmosphere.







 KOBOLD Group D-50739 Köln Robert-Perthel-Str. 9 Germany	 www.heinrichs.eu	Type: TM-T23-305I0350-R0L3-L-B-0-00 Ser. No.: 123456 MF-Date: 2018/10 TAG No.: TM008T*26958034 Tamb: -20°C to 60°C
	 0158	CONNECTION: DN15 PN40 Form B 2 WETTED PARTS: Tantalum PROCESS TEMP.: -40°C to 100°C PS: 40 bar PT: 60 bar PED / Art.3 Para.4 PN BODY: 0 bar Qmin = 40 kg/h Qmax = 350 kg/h Sensor Constant C: 84,322 Cable fittings : M20 x 1,5mm
 DMT 01 ATEX E 149X II 1/2 G Ex ia IIC T2...T6 Ga/Gb	 IECEx BVS 11.0084X Ex ia IIC T2...T6 Ga/Gb	Control Drawing: Consult Control Drawing for Warnings TM-CSA-1100 EXCITER CIRCUIT TYPE: EC1R
 NEPSI: GYJ17.1166X Ex ia IIC T2 .. T6 Ga/Gb	 Class I Div 1 Group A,B,C,D Class I Zone 0: AEx ia T5-T2 Ga C US CSA18CA70171067X	

Image 1: TM-T for process temperatures ranging from – 20 °C to 100 °C.

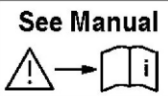
3.3 Mounting

The mounting instructions for the standard sensor also apply to the explosion-proof sensor.

3.3.1 Thermally insulated sensor

The sensor may be outfitted with thermal insulation, also in explosive atmospheres. However, so not to impair the junction box or connectors thermal ratings, the insulation shall only cover maximum the half of the sensors neck onto which the junction box or connector is mounted.

3.3.2 Heated sensor

The sensor can be externally heated to avoid crystallization in the flow tube. Any heating technique or device can be used. When using electrical heating devices, these must be suitable for use in the potentially explosive environment present.

It is the operator’s responsibility to ensure that the heating temperature does not exceed the maximum allowable temperature for the fluid and/or the maximum allowable temperature range for the potentially explosive atmosphere in which the device is being operated.

The maximum allowable temperature range for the fluid is indicated on the sensors rating plate.

It is also the operator’s responsibility to ensure that no hazards are created by hot surfaces pursuant to EN 1127-1 (Explosive atmospheres – Explosion prevention and protection) paragraphs 5.2 and 6.4.2.

3.3.3 Connection remote sensor – transmitter

A dedicated cable **SLI2Y (SP) CY 5 x 2 x 0.5 mm² [blue]** or similar is to be used for the electrical connection between sensor and the remote mounted transmitter. This cable, which is available from Heinrichs Messtechnik, has five twisted pairs, each of which has a foil shield, tinned copper mesh and filler cord. The tinned copper meshes are installed in the “shield” terminal in both the sensor and transmitter. All 5 cable pairs are shielded by a further tinned copper wire mesh. This external cable shield is connected to the housing via a dedicated EMC cable fitting, thus ensuring optimum noise immunity.

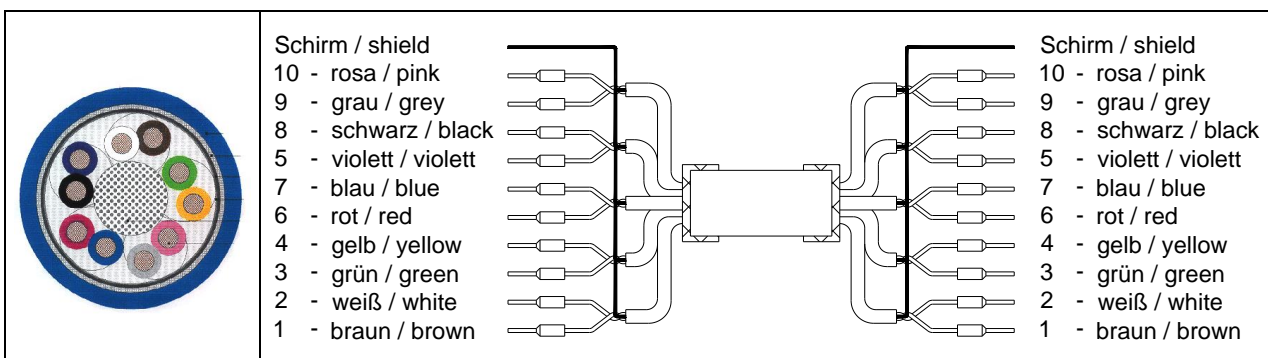

Image 2: Heinrichs standard cable: SLI2Y (SP) CY 5 x 2 x 0.5

The operator is to comply in all cases with the applicable installation regulations such as EN 60079-14 “Electrical apparatus for explosive gas atmospheres- Part 14: Electrical installations in hazardous areas”.

Applicable guidelines pertaining to the interconnection of intrinsically safe circuits must also be observed.

The following maximum cable parameters must be abided to:

$C_L = 100 \text{ pF/m}$ wire to wire

$L_L = 700 \text{ }\mu\text{H/km}$ wire to wire

$C_L = 170 \text{ pF/m}$ wire to shield

$L_L = 500 \text{ }\mu\text{H/km}$ wire to shield



Warning

If a connecting cable other than the Heinrichs Messtechnik cable is used, the intrinsic safety of the cable is to be validated using the cable's nominal values

3.4 EC Type-Examination Certificate for the sensors type TM, TMU and TM-SH

The sensors are certified with the following examination certificates:

CSA (North America)



CSA18CA70171067X
Class I Division 1 and 2, Group A,B,C,D
Class I Zone 1: AEx ia TX Ga

ATEX (Europe)



DMT 01 ATEX E 149 X
II 1/2G Ex ia IIC T6-T2 Ga/Gb

IECEX (Global)



IECEX BVS 11.0084 X
Ex ia IIC T6-T2 Ga/Gb

NEPSI (CHINA)



GYJ17.1166X
Ex ia IIC T2-T6 Ga/Gb

KCS (KOREA)



12-KB4B0-0116X
Ex ia IIC T6-T2

and are approved for the use in potentially explosive atmospheres. (hazardous classified locations)

The sensor may be used in such a way that inside the measuring tubes explosive atmosphere may be present often or for a long time (Zone 0).

3.5 Electrical Parameters



Warning

To ensure compliance with the requirements for explosive atmospheres, it is essential that the maximum electrical and thermal values set forth below are observed

3.5.1 Exciter circuit (terminals 8 and 9)

3.5.1.1 For exciter circuit type EC1

Voltage	U _i	30 V
Current	I _i	90 mA
Power	P _i	0.4 W
Effective internal capacitance	C _i	negligible
Effective internal inductance	L _i	4.38 mH

3.5.1.2 For exciter circuit type EC2

For connecting an intrinsically safe circuit with an Ex ia IIC type of protection, linear output characteristic and the following maximum values:

Voltage	U _o	30 V
Current	I _o	90 mA
Power	P _o	1 W
Effective internal inductance	L _i	4.38 mH < L _i < 220 mH

3.5.2 Sensor circuits (terminals 1 – 2 and 3 – 4)

Voltage	U _i	DC 30 V
Current	I _i	50 mA
Power	P _i	0.300 W
Effective internal capacitance	C _i	negligible
Effective internal inductance	L _i	14 mH
Output voltage	U _o	AC 0.3 V

3.5.3 Temperature sensor circuits (terminals 5 to 7)

Voltage	U _i	DC 30 V
Current	I _i	100 mA
Power	P _i	0.333 W
Effective internal capacitance	C _i	negligible
Effective internal inductance	L _i	negligible

3.5.4 Ambient temperature range Ta

The ambient temperature range is dependant on the type of connection, installation, process temperature and temperature class.

For determining the prevailing temperature class at the location of installation refer to the following tables as well as the relevant type certificate:

With HAN R23 plug

Neck extension (Between the TM, TMU or TM-SH* sensors, and the Harting HAN R23 Connector)	Process temp. (°C) -50 °C to ..	Ambient temp. range (°C) -40 °C to ..	Temperature class
without	40	45	T6
without	60	60	T5
60 mm	100	80	T4
160 mm	115	80	T4
160 mm	175	80	T3
160 mm	180	80	T2
260 mm	220	80	T2

CAUTION: The temperature ranges and classes printed in **BOLD and Cursive**, are **NOT** available for installation in North America

* TM-SH sensors are restricted to Tamb = 60 °C and T process = -40 °C to 60 °C, see Table coils.

Remote mount configuration (Junction box)

Neck extension length (Between the TM, or TMU sensor neck, and the J-Box) Sensors have a standard neck > 60mm	Process temp. (°C) -50 °C to ..	Ambient temp. range (°C) -40 °C to ..	Temperature class
without	40	40	T6
without	60	60	T5
without	100	80	T4
100 mm	115	80	T4
100 mm	175	80	T3
100 mm	180	80	T2
200 mm	220	80	T2

CAUTION: The temperature ranges and classes printed in **BOLD and Cursive**, are **NOT** available for installation in North America.

3.6 Connecting the sensor to a transmitter

The transmitter used in conjunction with a TM, TMU or TM-SH sensor must be listed for use in Canada and/or USA depending on its area of installation. The manufacturer's installation drawings shall be followed when installing this equipment.

It is essential that the output parameters of the transmitter correspond to those of the sensor.

3.6.1 Connecting cables

The connecting cables for power supply, signal outputs and sensor circuits must adhere to either the requirements of EN 60079-14 for Europe, Section 18 of the Canadian Electrical Code for Canada or Article NEC 504 and/or NEC 505 for USA.



Note:

- The connecting cables are to be installed in such a way that they are protected against mechanical damage and unduly high temperatures.
- The external diameters of the connecting cables must be compatible with the thickness range of the cable glands and rubber seals used.
- The cables and cable glands used must be compatible with the type of protection of the junction box being used.
- The dummy plugs used for unused cable glands must be compliant with the type of protection of the housing being used.
- It must be ensured that the cable gland gaskets are correctly seated..

3.6.1.1 Cable and conduit entries

Cable and conduit entries need to be certified for the type of protection of the transmitter and fit to the cables used.

See also EN 60079-14/10.3.

3.6.1.2 Equipotential bonding

Equipotential bonding between the sensor and transmitter is essential and must be established and maintained. Terminals are provided on the outside of the sensor and transmitter for this purpose.

4. Installation and Commissioning

4.1 Mounting

The mounting instructions for the standard sensor also apply to the explosion-proof sensor. Depending on the approval of the connected transmitter, the sensor may either be:

- Directly mounted, mechanically fastened to the transmitter producing a single unit.
or
- Separately installed and connected with a special sensor cable, whereby the maximum C_L and L_L of the connection cable must be observed.

Refer to the standard operating manual for the connection scheme of the sensor

4.1.1 General conditions for safe operation

- a) If the conditions described in this document are not adhered to or if there is any inappropriate interference with the equipment, all the manufactures warranties expire.
- b) Conditions described in this manual, as well as the permitted operating conditions which have been defined for the sensor and which are stated on the rating plates must be adhered to.
- c) Appropriate measures shall be met to prevent any unintentional or inadmissible damage to the device.
- d) The operator shall ensure that the equipment is only installed in areas which comply with the approved types of protection and environments.
- e) All connected electrical equipment must be suitable for its intended use.
- f) The operator shall ensure protection against lightning according to local regulations.
- g) For models with a junction box enclosure made from Aluminum alloy, ignition sources due to impact and friction sparks could occur. This shall be considered during installation, the danger of objects falling onto the sensor shall be excluded.
- h) Combination of the external barriers from the transmitter has not been assessed. Therefore each input wiring circuit to the sensors should be kept segregated from the other inputs as per requirements of the standards.
- i) For exciter coils type EC2 and EC2R the supply signal from the transmitter shall be pulsed with low duty cycle or non-repetitive.

4.1.2 Requirements for installation in all environments

- a) The installation of the intrinsically safe circuits requires a control drawing (system description), to be issued by the operator/erector.
- b) For ordinary locations installations to be supplied by a Limited Energy Source in accordance with CSA 61010-1-12/UL 61010-1.
- c) The equipment is only to be installed and connected in a de-energized state.
- d) The sensor is to be installed (from specialists) according to applicable regulations.

- e) When mounted separately (remote mount configuration), equipotential bonding between the sensor and transmitter is essential to guarantee conformity of the intrinsically safe circuits. Terminals are provided on the outside of the sensor and transmitter for this purpose
- f) It is to be ensured that the intrinsically safe circuits of the sensor cable are not laid together with non-intrinsically safe circuits.
- g) When using a connection cable other than the manufactures specified cable, the intrinsic safety of the cable is to be validated using the cables nominal parameters. Field wiring using multi-conductor cable shall either have each conductor pair enclosed in a grounded metal shield, or each conductor shall have a minimum of 0.25mm (0.01") insulation thickness.

The following maximum values apply:

Wire to wire	-	$C_L = 100\text{pF/m}$	$L_L = 0.7\text{mH/km}$
Wire to shield	-	$C_L = 170\text{pF/m}$	$L_L = 0.5\text{mH/km}$

- h) If the sensor is used at an ambient temperature of less than $-20\text{ }^\circ\text{C}$ or greater $60\text{ }^\circ\text{C}$, suitable cables, cable entries and conduit entries are to be used.
- i) The operational wall thickness of the stainless steel flow tubes may be $< 1\text{ mm}$. In this case, the operator is to ensure that in the area of these tubes, no risk of damage by the medium or through mechanical damage shall occur.
- j) The sensor may be used in such a way that in the measuring tubes an explosive atmosphere may be present occasionally or for a long period of time.
- k) Seized screws or adhering joints (e.g by frost or corrosion) are not to be opened with force in the presence of a potentially explosive atmosphere.
- l) Where substances of explosion group "A" or "IIC" are present and the presence of an Ex-atmosphere is considered possible, only non-sparking tools shall be used.
- m) The electrical connections from the sensor to the junction box are made by means of a connection flange. Care must be taken to guarantee the IP protection class.

4.2 Ex relevant screw and bolt torques

Potential Equalisation fixation	6 Nm
Nuts sensor-neck/J-box (PE)	6 Nm
Screws J-box lid (Aluminium)	2 Nm
Screws J-box lid (Polyester)	1.2 Nm
Cable glands to J-box adapter	12 Nm
Cable gland caps	8 Nm

5. Maintenance and repair work

5.1 Definition of terms according to IEC 60079-17:

Maintenance: defines a combination of any actions carried out to retain an item in, or restore it to, conditions in which it is able to meet the requirements of the relevant specification and perform its required functions.

Inspection: defines any action comprising careful scrutiny of an item carried out either without dismantling, or with the addition of partial dismantling as required, supplemented by means such as measurement, in order to arrive at reliable conclusion as to the condition of an item.

Visual inspection: defines an inspection which identifies, without the use of access equipment and tools, those defects, such as missing bolts, which will be apparent to the eye.

Close inspection: defines an inspection which encompasses those aspects covered by a visual inspection and, in addition, identifies those defects, such as loose bolts, which will be apparent only by the use of access equipment, for example steps, where necessary, and tools.

Detailed inspection: defines an inspection which encompasses those aspects covered by a close inspection and, in addition, identifies those defects, such as loose terminations, which will only be apparent by opening the enclosure, and/or using, where necessary, tools and test equipment.

- a) Maintenance or replacement work must be carried out by qualified personnel only, i.e. personnel qualified according to TRBS 1203 or similar.
- b) Only auxiliary components which comply with all North American requirements, national directives and legislations may be used in potentially explosive atmospheres
- c) At the presence of Ex-atmospheres, the equipment must be regularly cleaned. The intervals are to be defined by the operator in compliance with the environmental rules valid at the place of operation.
- d) After maintenance and repair works have been performed, all barriers and notices removed for that purpose must be returned to their original place.
- e) In the event that faults of the equipment are detected, the equipment is to be removed. The internal components cannot be maintained by the customer. The equipment is to be returned to the manufacturer for inspection.
- f) Fuses, with the exception of the replaceable mains fuse, may **not** be replaced by the operator, since affected zener-diodes must also be simultaneously replaced. This work requires a follow-up adjustment, which can only be carried out at the manufacturer's factory.

Activity		Visual inspection	Close inspection	Detailed inspection
		3 month interval	6 month interval	12 month interval
1	Visual inspection of equipment for intactness, removal of dust settlements	X		
2	Check of electrical system for intactness and functionality			X
3	Check of entire system		User's responsibility	

5.2 Fault elimination

No repairs or modifications may be performed on equipment that is operated in conjunction with explosive atmospheres. Such equipment shall only be repaired by expert personnel trained and authorized to do so.

Damaged threaded or flat joints which may impair the IP protection of the enclosure shall not be repaired or modified. The equipment shall be returned to the manufacturer for repair and replacement.

5.3 Disposal

Packaging material and worn components shall be disposed of according to the regulations applicable in the country of installation.

6. Relevant Standards for Hazardous Locations

6.1 (CSA, North America)

CAN/CSA C22.2 No. 0-10	General Requirements – Canadian Electrical Code, Part II
CAN/CSA C22.2 No. 61010-1-12	Safety Requirements for Electrical Equipment for Measurement, Control, and Laboratory Use--Part 1: General Requirements
CAN/CSA C22.2 No. 60079-0-19	Explosive atmospheres – Part 0: General Requirements
CAN/CSA C22.2 No. 60079-11-14	Explosive atmospheres – Part 11: Equipment protection by intrinsic safety "i"
ANSI/ISA - 60079-0:2020	Explosive Atmospheres - Part 0: Equipment - General Requirements
ANSI/ISA - 60079-11:2014	Explosive atmospheres – Part 11: Equipment protection by intrinsic safety "i"
UL 61010-1 – 3rd Edition	Safety Requirements for Electrical Equipment for Measurement, Control, and Laboratory Use - Part 1: General Requirements

6.2 ATEX (Europe) / IECEx

DIN EN 60079-0	Explosive locations: General requirements
DIN EN 60079-11	Explosive locations: Equipment protection by intrinsic safety "i"
DIN EN 60079-26	Explosive locations: Equipment with Equipment Protection Level (EPL) Ga

7. EU Declaration of conformity



EU-Konformitätserklärung
EU-Declaration of Conformity

Nº. 21-4142-01



<p>Hersteller: <i>Manufacturer:</i></p>	<p>Heinrichs Messtechnik GmbH Robert-Perthel-Strasse 9 50739 Köln</p>
<p>Produktbeschreibung: <i>Product description:</i></p>	<p>Coriolis Durchflussmessgerät UMC4 für Verwendung mit der Sensorreihen TM* und HPC Coriolis Flowmeter UMC4 for use with the Sensor series TM* and HPC</p>

Hiermit erklären wir, in alleiniger Verantwortung, dass das oben genannte Messsystem den Anforderungen der folgenden EU-Richtlinien, einschließlich allen bis heute veröffentlichten Änderungen bzw. Nachträgen entspricht:
We declare herewith, in sole responsibility, that the product described above is conform with the provisions of the following EU-directives, including all published changes and amendments as of today:

2014/30/EU (EMC)	EU-Richtlinie über die Elektromagnetische Verträglichkeit <i>EU-Directive relating to electromagnetic compatibility</i>
2014/34/EU (ATEX)	EU-Richtlinie über Geräte zur Bestimmungsgemäße Verwendung in explosionsgefährdeten Bereichen. <i>EU-Directive relating to electrical equipment intended for use in potentially explosive atmospheres</i>
2014/35/EU (LVD)	EU-Richtlinie über die Bereitstellung elektrischer Betriebsmittel zur Verwendung innerhalb bestimmter Spannungsgrenzen auf dem Markt <i>EU-Directive relating to the making available on the market of electrical equipment designed for use within certain voltage limits</i>
2014/68/EU (PED)	EU-Richtlinie zur Harmonisierung der Rechtsvorschriften der Mitgliedstaaten über die Bereitstellung von Druckgeräten auf dem Markt <i>EU-Directive on the harmonisation of the laws of the Member States relating to the making available on the market of pressure equipment</i>

Anhang N und X sind ein integraler Bestandteil dieser Erklärung
Annex N and X are an integral part of this declaration

Köln, den 21.03.2021



Joseph Burke
(Explosionsschutzbeauftragter /
Explosion Protection Representative)



i.V. Olaf Paul
(Stellvertretende Druckgerätebeauftragter /
Deputy PED Representative)



Guido Thometzki
(Geschäftsführung / Managing Director)

Kontakt: Tel: +49 (221) 49708-0
Contact: Email: info@heinrichs.eu
 Web: www.heinrichs.eu

Konformitätserklärung-UMC4_21-4142-01.docx
Seite 1 von 3



**Anhang N zur EU-Konformitätserklärung
Annex N of the EU-Declaration of Conformity**



Nº. 21-4142-01

Produktbeschreibung: **Coriolis Durchflussmessgerät UMC4 für Verwendung mit der Sensorreihen TM* und HPC**
 Product description: **Coriolis Flowmeter UMC4 for use with the Sensor series TM* and HPC**

Die Konformität mit den auf Seite 1 genannten Richtlinien diese Erklärung wird nachgewiesen durch die Einhaltung folgenden Normen (abhängig von Gerätvariant):
 Conformity to the Directives referred to on Page 1 of this Declaration is assured through the application of the following standards (depending on version of device):

Richtlinie Direktive	Norm –Ref. Nr. Standard / Ref. Nº.	Ausgabe Edition	Norm Beschreibung Standard Description	UMC4	TM/ TMU/ TME/ TMR	TM-SH	HPC
	DIN EN -						
2014/30/EU	61000-6-2	2011-06	Immunity Industrial enviroment	X			
	61000-6-3	2012-11	Emission residential enviroment	X			
	55011	2011-04	Radio frequency disturbance	X			
	61326-1	2011-07	EMC requirements	X			
2014/34/EU	60079-0	2012+ A11:2013	General requirements	X			
	60079-0	2018	General requirements		X	X	X
	60079-1	2015	Flameproof Enclose „d“	X			
	60079-11	2012	Intrinsic Safety „i“	X	X	X	X
	60079-26	2015	Protection Level (EPL) „Ga“	X	X	X	
2014/35/EU	61010	2011-07	Safety requirements	X	X	X	
2014/68/EU	AD 2000-Merkblätter		Module H		X	X	

X: Zutreffende Norm / Applicable Standard

Name und Anschrift der Notifizierte Stelle / Name and Address of the Notified Body

TÜV-SÜD Industrie Service GmbH
 TÜV SÜD Gruppe
 Westendstraße 199
 D-80686 München
 ID-Nr. / ID-Nº.: RL 2014/68/EU: 0036

DEKRA Testing and Certification GmbH
 Carl-Beyling-Haus
 Dinnendahlstraße 9
 D-44809 Bochum
 ID-Nr. / ID-Nº.: RL 2014/34/EU: 0158



CE Anhang X zur EU-Konformitätserklärung
Annex X of the EU-Declaration of Conformity



Nº. 21-4142-01

Produktbeschreibung: **Coriolis Durchflussmessgerät UMC4 für Verwendung mit der Sensorreihen TM* und HPC**
 Product description: **Coriolis Flowmeter UMC4 for use with the Sensor series TM* and HPC**

Gerät Zulassungen / Device certification

EG-Baumusterprüfbescheinigung EC-type examination certificate	Nachtrag Supplement	Kennzeichnung Marking Für kompletten Kennzeichnung, siehe Betriebsanleitung	UMC4	TM/TMU/ TME/TMR	TM-SH	HPC
BVS 10 ATEX E 110 X	1	II (1) 2G	X			
DMT 01 ATEX E 149 X	8	II 1/2G		X	X	
CML 19 ATEX 2096 X	0	II 1G II 1/2D				X

X: Zutreffende Norm / Applicable Standard

Die oben genannten Produkte entsprechen der Richtlinie 2014/34/EU. Neue Editionen können bereits eine oder mehrere der in den jeweiligen EU-Baumusterprüfbescheinigungen genannten Normen ersetzt haben. Der Hersteller erklärt, dass alle Produkte erwähnt in dieser Konformitätserklärung auch der Anforderungen der neuen Editionen einhalten, da die veränderten Anforderungen der neuen Editionen haben entweder keinen Einfluss auf das Produkt, oder das Produkt die Anforderungen erfüllt.

The above-mentioned products comply with the requirements of Directive 2014/34/EU. New editions may have already replaced one or more of the Standards stated in the respective EU-Type-examination Certificates. The manufacturer declares that all products mentioned in this Declaration of Conformity also comply with the requirements of the new editions since the changed requirements of the new editions either do not affect the product, or the product also fulfills the requirements.

Heinrichs Messtechnik GmbH

Robert-Perthel-Straße 9
 50739 Köln
 Telefon 0221/49708-0
 Telefax 0221/49708-178
<http://www.heinrichs.eu>
info@heinrichs.eu

Bankverbindung

Dresdner Bank Köln
 BLZ 370 800 40
 Konto-Nr. 0955 051300
 IBAN :
 DE58 3708 0040 0955 0513 00
 SWIFT-BIC: DRES DE FF 370

Erfüllungsort und Gerichtsstand:

Köln
 Amtsgericht Köln HRA 37040
 Ust.IDNr.: DE813416533
 Steuer-Nr.: 217/5743/0386

Geschäftsführer

Dipl. Ing. (FH)
 Guido Thometzki

