

**Operating Instructions  
for  
Level Switch  
Tuning Fork Principal**

**Model: NWS**



## 1. Contents

---

1. Contents.....	2
2. Note .....	3
3. Instrument Inspection.....	3
4. Regulation Use.....	3
5. Operating Principle.....	4
6. Use in Hazardous Areas (NWS-2E) .....	4
6.1 Device function .....	4
6.2 Commissioning/Installation .....	5
6.3 Designation.....	5
6.4 Temperature resistance .....	6
7. Mechanical Connection.....	6
8. Electrical Connection .....	7
8.1 NWS-...200 .....	7
8.2 NWS-...23/24; NWS-...2W/2H; NWS-...2E (ATEX certification) .....	9
9. Settings.....	10
9.1 Settings for NWS-...200.....	10
9.2 Settings for NWS-...23/24/2W/2H and NWS-2E .....	12
10. Technical Information.....	15
11. Order Codes .....	17
12. Service and Maintenance.....	17
13. Trouble Shooting.....	17
14. Recommended Spare Parts .....	18
15. Disposal .....	18
16. Dimensions .....	19
17. Declaration of Conformance .....	21
18. Supplement to the EC-Type Examination certificate .....	22
19. IECEx Certificate.....	25

### Manufactured and sold by:

Kobold Messring GmbH  
Nordring 22-24  
D-65719 Hofheim/Germany  
Tel.: +49(0)6192-2990  
Fax: +49(0)6192-23398  
E-mail: info.de@kobold.com  
Internet: www.kobold.com

## **2. Note**

---

Please read these operating instructions before unpacking and putting the unit into operation. Follow the instructions precisely as described herein.

The devices are only to be used, maintained and serviced by persons familiar with these operating instructions and in accordance with local regulations applying to Health & Safety and prevention of accidents.

When used in machines, the measuring unit should be used only when the machines fulfil the EWG-machine guidelines.

## **3. Instrument Inspection**

---

Instruments are inspected before shipping and sent out in perfect condition.

Should damage to a device be visible, we recommend a thorough inspection of the delivery packaging. In case of damage, please inform your parcel service / forwarding agent immediately, since they are responsible for damages during transit.

### **Scope of delivery:**

The standard delivery includes:

- Level Switch            model: NWS
- Operating instructions

## **4. Regulation Use**

---

Kobold model NWS Liquid-Level Switches are designed to be wired as 2-wire or 3-wire switches and can be universally installed in any position in containers and piping. They can be used in many types of liquids including oils, water, paints and varnishes, sauces, milk, carbonated liquids and foamy oils. The liquid may have a maximum viscosity of 5000 cSt. At higher viscosities, the response time may increase. NWS Liquid-Level Switches are ideally suited for use in hygienic and sterile applications and designed to withstand CIP cleaning methods at temperatures up to 150 °C.

Any use of the device which exceeds the manufacturer's specification may invalidate its warranty. Therefore any resulting damage is not the responsibility of the manufacturer. The user assumes all risk for such usage.

## 5. Operating Principle

---

The KOBOLD liquid level switch NWS is designed as a 2 and 3-wire switch and can be universally used in vessels and pipelines. The NWS operates on the tuning fork principle in air at resonance frequency. A piezoelectric crystal is used for excitation of oscillations and for monitoring the actual oscillation frequency. When the fork is immersed in liquid, the frequency changes: this change is detected electronically and the output signal is changed. The NWS operates as a two-wire switch in series with the load. The simple electronic switch is operated by the liquid. The NWS can also be connected to a PLC through a third terminal.

### **Special Features:**

The NWS has a switch status indicator with LED, which can be seen continuously through a lens in the cover. The LED flashes approximately once every second, when the NWS has switched off and goes onto a permanent light, when the NWS is switched on. The LED is a visible confirmation that the NWS is working correctly and that the condition of the wet side is correctly indicated. With a selector switch the NWS can be set either as an upper limiter or as a lower limiter.

## 6. Use in Hazardous Areas (NWS-2E)

---

### 6.1 Device function

The intrinsically safe NAMUR oscillating fork sensor is used to detect the fill levels of combustible and non-combustible liquids. The sensor is supplied with current from a switching amplifier with an intrinsically safe output circuit in accordance with the NAMUR specification and behaves accordingly when the oscillating fork is dampened by liquid or can oscillate freely. The sensor can be used in all zones in gaseous hazardous areas.

## 6.2 Commissioning/Installation

- The devices may be installed in zones 0, 1 and 2. The intrinsically safe circuits must be installed (by specialists) in conformance with the applicable installation requirements (certification document of installer, protected routing of the intrinsically safe circuits, etc.).
- The devices are constructed in accordance with protection type IP 65. If applicable, they must be protected against adverse environmental conditions.
- The EU model test certificates must be complied with. Any “special regulations” contained in them must be followed.
- The device should only be used for its intended use.
- The connection with the associated and/or intrinsically safe equipment must be separately checked.
- The sensors must be grounded to discharge accumulated electrostatic charge.
- At an ambient temperature area of - 5 .. + 70 °C the connected electrical cable may be mechanically moved. Furthermore at an ambient temperature area of - 20 .. + 70 °C the electrical cable must be mounted in a fixed and static manner.
- The tuning fork should be protected against external hits.
- The connection area of the plug connection version and the connection cable should be protected against electrostatic charges during its use in zone 0.
- The sensors are by default produced with 1.5 m long cable or with a plug. In this case a Ci of 8 pF should be taken into account, the internal inductance is negligible.
  - For longer cable length an additional Lc value of 0.14 nF m<sup>-1</sup> and LI value of 0,65 µH m<sup>-1</sup> per each meter of supplied cable should be considered.

## 6.3 Designation

Model: NWS\*\*\*2E\* \*\*\*\*

 II 1 G Ex ia IIC T6 Ga

BVS 03 ATEX E 119

IECEX BVS 13.0004

Identification number: 0158

Production-No.: SN: E999999 (consecutively numbered)

## 6.4 Temperature resistance

The values for ambient temperatures ranging from -20 °C up to the values indicated in the following table apply to this sensor, depending on the max. temperature of the oscillating forks in the sensor:

Ambient temperature	70 °C	70 °C
Medium temperature	75 °C	90 °C
Temperature class	T6	T5

## 7. Mechanical Connection

---

During installation and removal, recognised and applicable engineering practices and regulations shall be observed. When working on electrical and pneumatic plants, the special safety requirements shall be observed.

The NWS switch can be installed in containers or piping by screwing it into a threaded mounting flange or other type of mounting device. The threaded connection must be sealed with Teflon (PTFE) tape. Be sure to turn the switch at the hexagonal drive; do not install the switch by turning it at the housing.

After installation, the NWS-...200 can be rotated up to 330° to locate the M16 cable connection (supplied with the device) in a suitable position.

If the switch is installed in a horizontal position, the tuning fork gap should be positioned vertically so that the liquid can drain from it. If the liquid being monitored is of high viscosity, the switch should be installed so that it extends the maximum distance into the container or piping in order to prevent the thick liquid from sticking and accumulating between the fork and the container or pipe wall. If the switch is installed in piping, the tuning fork gap should be positioned so that it is parallel to the pipe axis.

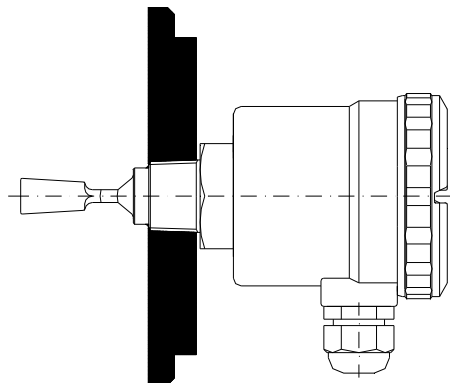

## 8. Electrical Connection



**Attention! Be sure that the supply voltage of your system is the same as that specified on the device nameplate. Make sure that the electrical supply lines are de-energised when connecting the device!**

### 8.1 NWS-...200

#### Series wiring with a 2-wire connection

Please note:

- The switch must always be operated in series with a load.
- The switch must be grounded at terminal 1.
- The switch draws a continuous operating current of less than 3.5 mA (even when it is "off"). For this reason, it cannot be used for loads that do not allow an "off" current (such as for gas discharge lamps).
- The maximum load current for the switch is 500 mA. The user must provide suitable protective measures to ensure that this load limit is not exceeded.

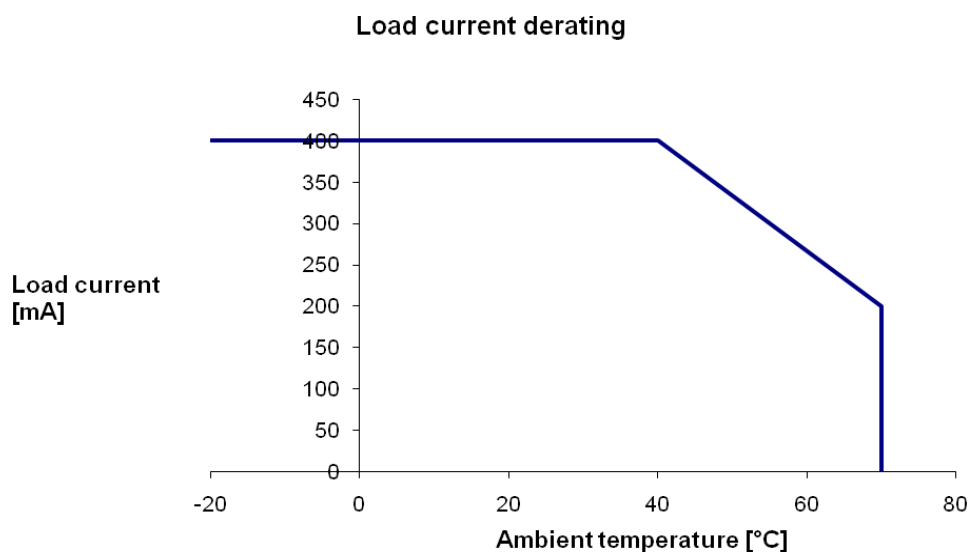

**Wiring diagram: 2-wire 24-240V<sub>AC/DC</sub>, series load,  $I_{\max} \leq 400\text{mA}$**

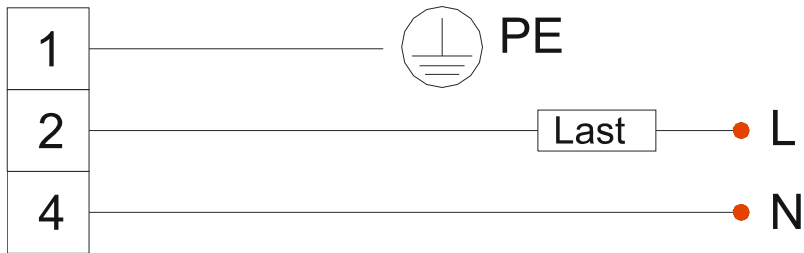

## PLC connection with 3-wire connection

Please note:

- An integral series resistance is used in the 3-wire circuit to generate a PLC-compliant voltage signal.
- The signal can be picked up at terminal 4.
- PLC programming devices or computers from various manufacturers will have different "OFF" threshold voltages. If you should have problems with this setting, please contact us for assistance.

**Wiring diagram: 3-wire,  $V_S = 24\text{ V}_{\text{DC}}$ ,  
output PNP:  $U_{\text{HIGH}} \sim 20\text{ V}$ ;  $U_{\text{LOW}} \sim 3.5\text{ V}$ ;  $I_{\max} \leq 400\text{ mA}$**

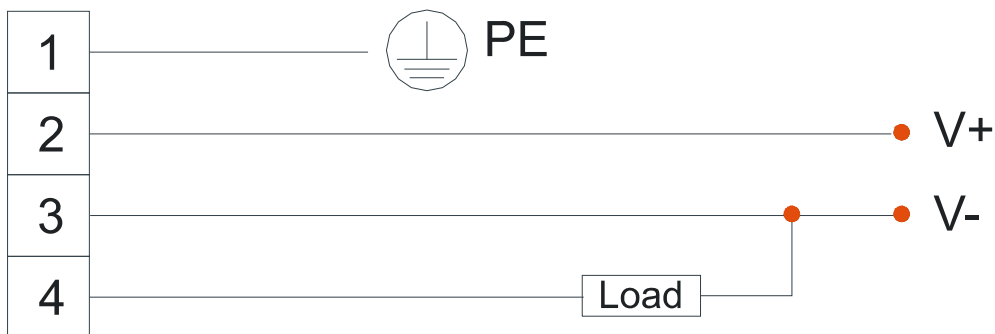



## 8.2 NWS-...23/24; NWS-...2W/2H; NWS-...2E (ATEX certification)

- Make sure that the electrical supply lines are de-energised.
- Connect the device using the M12x1 plug or a connection cable as shown in the wiring diagram below.
- Matching connectors with different cable lengths are optionally available.
- Make sure that the installation is properly performed and that the IP protection level is maintained.

Wiring diagram NWS-...23/24 (24 V<sub>DC</sub>)      Wiring diagram NWS-...2W/2H

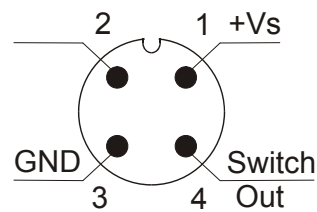
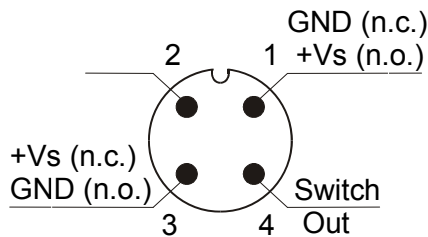

Wiring diagram NWS-2ES.. (NAMUR, ATEX)

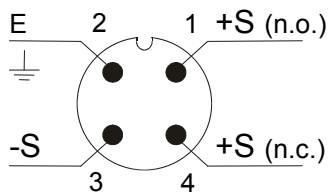

### Cable pin assignment

Strand colour	NWS-...23/24	NWS-...2W/2H
brown	+Vs(n.o.) / GND	+Vs
blue	GND / +Vs (n.c.)	GND
black	Switch Out	Switch Out

Lead-/Pinnumber	NWS-...2EF
1	+S (n.o.)
2	ground
3	-S
4	+S (n.c.)

Wiring examples NWS-...2E... with Power supply unit acc. to IEC 60947-5-6

Plug M12x1

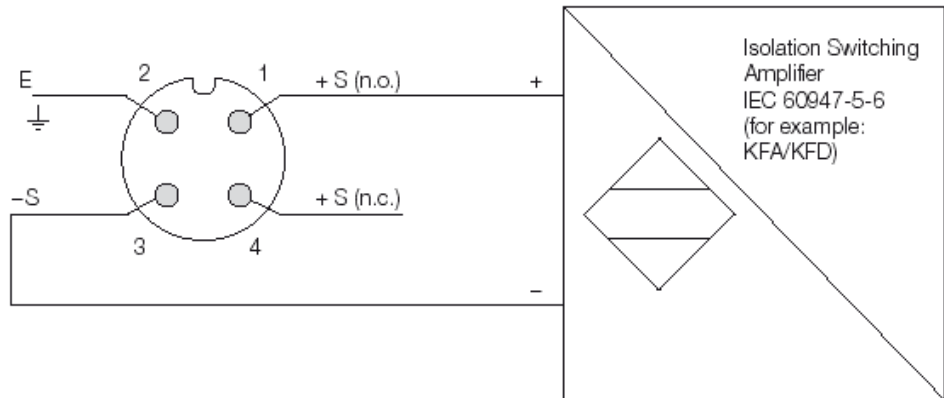

Cable 1.5 m

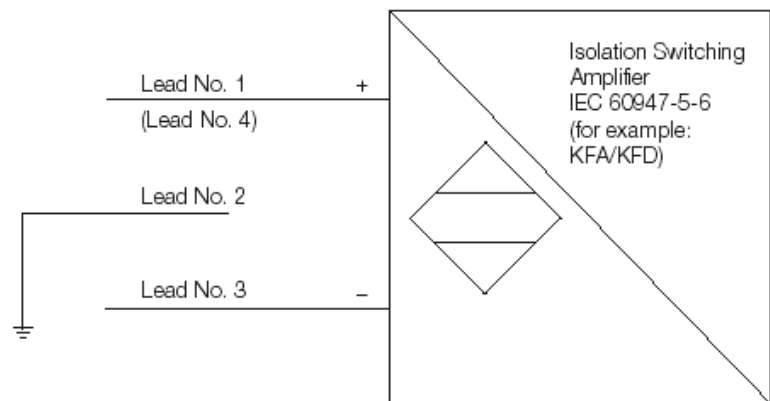

## 9. Settings

### 9.1 Settings for NWS-...200..

#### 9.1.1 Signalling the operating status

The NWS has an output status indicator with an LED monitor that can be viewed continuously through a lense in the cover. The LED flashes approximately once every second when the NWS is off. It is continuously illuminated when the NWS is switched on. The LED provides visual confirmation that the NWS is operating correctly and that the status of the wet side is correctly displayed. With its operating mode switch, the NWS can be set to operate as either an N/C contact or an N/O contact.

#### 9.1.2 Operating mode selector switch

The operating mode switch is positioned on the circuit board on the right about the LED. If the switch is operated as an N/C contact (upper limiter), the operating mode must be set to DRY-ON, in order to obtain the maximum fail-safe behaviour. The device completes the circuit in the dry state (empty state) so that a fault at the device or in the wiring results in a voltage drop that causes an alarm to be triggered (break circuit). Conversely, if the switch is to WET-ON, the device operates as an N/O contact (lower limiter) in fail-safe mode, in which case the fork is normally immersed in liquid.

### 9.1.3 Calibration mode

Each appliance is adjusted by the factory to record fluids with density 1,0 kg/l (water). It is not usually necessary to alter this pre-adjustment. In extreme situations, however, such as with very light fluids at high temperatures or highly viscous fluids, which produce a significantly extended reaction time from dry to wet, it can be advantageous to alter the pre-adjustment. In order to attain the calibration mode the Setup button must be activated and held, then the supply voltage must be switched on. After approximately 1 second the LED goes on, after 2 seconds the LED goes out, then let go of the Setup button – the appliance stays now in the main menu of the calibration mode.

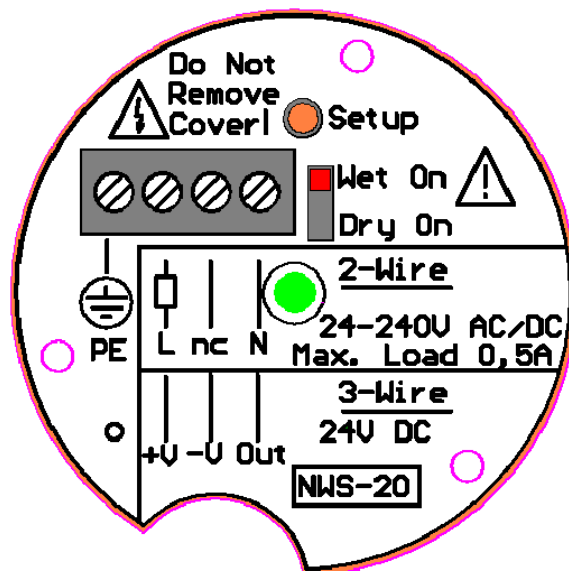

There is a choice of options in the main menu - Switchpoint Calibration, Hysteresis Level and LED Mode. The LED indicates the selected option:

- Switchpoint Calibration: LED flashes briefly 1x, then LED 2 seconds off.
- Hysteresis Level: LED flashes briefly 2x, then LED 2 seconds off.
- LED Mode: LED flashes briefly 3x, then LED 2 seconds off.

The option points are repeated in an infinite loop.

In order to get access to an option the Setup button must be activated briefly when the LED has signalled the requested option point.

#### Switchpoint Calibration:

The "Switchpoint Calibration Mode" is signalled by: LED 1x briefly off, then LED 2 seconds on.

Dip the tuning fork as far as the required switchpoint (1/2 – 2/3 of the fork length) in the medium and activate the Setup button. The calibration is made.

A successful calibration is signalled by the LED flashing quickly three times. Hysteresis and LED Mode are set back to default! After calibration the switch back to the main menu takes place.

#### Hysteresis Level:

The "Hysteresis Level Mode" is signalled by: LED 2x briefly off, then LED 2 seconds on. Briefly activate the Setup button to get to the submenu.

- Hysteresis Level 1 (approx. 1-1.5mm): LED flashes briefly 1x, then LED 2 seconds off.
- Hysteresis Level 2 (approx. 3-4.5mm, Standard): LED flashes briefly 2x, then LED 2 seconds off.
- Hysteresis Level 3 (approx. 5-7.5mm): LED flashes briefly 3x, then LED 2 seconds off.

The choice of options is repeated in an infinite loop. To select an Hysteresis Level, the Setup button must be activated after the flashing of the relevant LED. Three quick flashes of the LED signal that an option has been selected, then the switch back to the main menu is made.

## **LED Mode:**

The "LED Mode" is signalled by: LED briefly 3x off, then LED 2 seconds on. Briefly activate the Setup button in order to attain the option menu LED Mode.

- LED Mode 1 (Standard): LED flashes briefly 1x, then LED 2 seconds off. LED shows the status of the switch output
- LED Mode 2: LED flashes briefly 2x, then LED 2 seconds off. LED indicates whether the tuning fork is wetted or not

The choice of options is repeated in an infinite loop. In order to select an "LED Mode" the button must be briefly activated after the relevant flashing of the LED. Three quick flashes of the LED signal that an option has been selected. When the LED Mode has been successfully selected, the switch back to the main menu is made.

In order to leave the calibration mode, the appliance must be separated from the voltage supply for approx. 10 seconds

### **9.1.4 Test Function NWS-20**

Through the pressing and holding of the setup button, independent of the state of NWS, the switching output can be temporarily switched off. During the test phase, the LED blinks rapidly. Releasing the button returns the NWS after ca. 3 sec. to the current operating condition.

## **9.2 Settings for NWS-...23/24/2W/2H and NWS-2E**

### **9.2.1 Signalling the operating status**

The NWS has an output status indicator with an LED monitor that can be viewed continuously through a lense in the cover. The LED flashes approximately once every second when the NWS is off. It is continuously illuminated when the NWS is switched on. The LED provides visual confirmation that the NWS is operating correctly and that the status of the wet side is correctly displayed. With its operating mode switch, the NWS can be set to operate as either an N/C contact or an N/O contact.

## 9.2.2 Selecting operating mode

By reversing the polarity of the power supply, the switching function of the NWS-...23/24 can be changed from a N/C contact to a N/O contact.

In the case of the NWS-...2W/2H (WHG), the switching function cannot be changed for reasons of safety. This electronic switch opens in case of wetting, a faulty sensor or a power failure.

For the NWS-2E the operating modus is selected by connecting the corresponding connector (plug connector or cable pin assignment) (see 8.2).

Function	Signalling	NAMUR-output	fork
N/C	LED on	$\geq 2.1 \text{ mA}$	uncovered
	LED flashes quickly	$\leq 0.8 \text{ mA}$	covered
N/O	LED on	$\geq 2.1 \text{ mA}$	covered
	LED flashes quickly	$\leq 0.8 \text{ mA}$	uncovered

## 9.2.3 Calibration mode NWS-23/24/2W/2H and NWS-2E

Each appliance is adjusted by the factory to record fluids with density 1,0 kg/l (water). It is not usually necessary to alter this pre-adjustment. In extreme situations, however, such as with very light fluids at high temperatures or highly viscous fluids, which produce a significantly extended reaction time from dry to wet, it can be advantageous to alter the pre-adjustment. In the calibration mode for NWS-2E, the NAMUR loop current changes with the state of the LED signal. Therefore, the subsequent signal evaluation should be suppressed during the calibration process. In order to attain the calibration mode the test magnet must be placed at the label marking and held, then the supply voltage must be switched on. After approximately 1 second the LED goes on, after 2 seconds the LED goes out, then remove the test magnet – the appliance stays now in the main menu of the calibration mode.

There is a choice of options in the main menu - Switchpoint Calibration, Hysteresis Level and LED Mode (not NWS-2E). The LED indicates the selected option:

- Switchpoint Calibration: LED flashes briefly 1x, then LED 2 seconds off.
- Hysteresis Level: LED flashes briefly 2x, then LED 2 seconds off.
- LED Mode: LED flashes briefly 3x, then LED 2 seconds off (not NWS-2E).

The option points are repeated in an infinite loop.

In order to get access to an option the test magnet must be placed briefly when the LED has signalled the requested option point.

## **Switchpoint Calibration:**

The "Switchpoint Calibration Mode" is signalled by: LED 1x briefly off, then LED 2 seconds on.

Dip the tuning fork as far as the required switchpoint ( $1/2 - 2/3$  of the fork length) in the medium and activate by placing the test magnet briefly. The calibration is made.

A successful calibration is signalled by the LED flashing quickly three times. Hysteresis and LED Mode are set back to default! After calibration the switch back to the main menu takes place.

## **Hysteresis Level:**

The "Hysteresis Level Mode" is signalled by: LED 2x briefly off, then LED 2 seconds on. Activate by placing the test magnet briefly to get to the submenu.

- Hysteresis Level 1 (approx. 1-1.5mm): LED flashes briefly 1x, then LED 2 seconds off.
- Hysteresis Level 2 (approx. 3-4.5mm, Standard): LED flashes briefly 2x, then LED 2 seconds off.
- Hysteresis Level 3 (approx. 5-7.5mm): LED flashes briefly 3x, then LED 2 seconds off.

The choice of options is repeated in an infinite loop. To select an Hysteresis Level, the test magnet must be placed briefly after the flashing of the relevant LED. Three quick flashes of the LED signal that an option has been selected, then the switch back to the main menu is made.

## **LED Mode (not NWS-2E):**

The "LED Mode" is signalled by: LED briefly 3x off, then LED 2 seconds on.

Briefly activate the Setup button in order to attain the option menu LED Mode.

- LED Mode 1 (Standard): LED flashes briefly 1x, then LED 2 seconds off. LED shows the status of the switch output
- LED Mode 2: LED flashes briefly 2x, then LED 2 seconds off. LED indicates whether the tuning fork is wetted or not

The choice of options is repeated in an infinite loop. In order to select an "LED Mode" the test magnet must be placed briefly after the relevant flashing of the LED. Three quick flashes of the LED signal that an option has been selected. When the LED Mode has been successfully selected, the switch back to the main menu is made.

In order to leave the calibration mode, the appliance must be separated from the voltage supply for approx. 10 seconds

### **9.2.4 Test function**

The magnet supplied with the device can be used to switch off the electrical output of the NWS- independent of status of the tuning fork. In this case, the magnet must be placed on the location indicated on the device nameplate. After approximately 2 seconds, the NWS- switches the output off and the LED begins blinking. After the magnet is removed, the output returns after 3 seconds to its previous state.

### 9.2.5 Selecting operating mode

The choice of plug connector or cable pin assignment determines whether the level switch is operated as an N/C contact or an N/O contact (see the section “Electrical connection” below).

## 10. Technical Information

Fork:	stainless steel 1.4404
Process connection:	stainless steel 1.4404
Electronic housing:	NWS-...200: PAG, glass-fibre-reinforced cover with window, 330° rotatable all other types: stainless steel 1.4301
Process connections:	Pipe thread DIN EN 10226-1, NPT thread, Tri-Clamp, Pipe connection DIN 11851 (sanitary connection), Aseptic-connection DIN 11864, DRD flange, Flange B 25 PN 40 DN 2527, Flange B 50 PN 40 DN 2527, Flange ANSI B 16.5 - 1", 300 lbs, Flange ANSI B 16.5 - 2", 300 lbs
Protection:	plastic housing: IP 65 (NWS-...200) stainless steel housing, plug connection: IP 67 stainless steel housing, cable connection: IP 68
Max. operating pressure:	45 bar Flange connection: see pressure steps
Max. medium temp.:	130 °C (NWS-..200..) 90 °C (for all other NWS) short-time 150 °C for CIP (valid for all models NWS)
Min. medium density	0.8 kg/L (lower on request)
Ambient temperature:	-20 °C...+70 °C
<b>Power supply</b>	
NWS-...200...:	24...240 V <sub>DC/AC</sub> (50/ 60 Hz); 2-wire; 24 V <sub>DC</sub> , 3-wire
NWS-...23/24/2W/2H...:	24 V <sub>DC</sub> , 3-wire
NWS-...2E..(ATEX):	Isolation Switching Amplifier to IEC 60947-5-6 (Namur) necessary (for example: REL-6)
Delay:	1 s wet /dry 1 s dry / wet
Viscosity:	5000 mm <sup>2</sup> /s max. at 25 °C (influence on the response time)

Hysteresis: 4 mm vertical, 1 mm horizontal  
Repeatability:  $\pm 1$  mm at ambient temperature  
Weight: 0.5 kg (for R  $\frac{3}{4}$  and  $\frac{3}{4}$  NPT)

**Electrical Connection:**

NWS-...200...: cable connection: M 16 x 1.5  
terminal: max. 1.5 mm<sub>2</sub> (26-14 AWG)  
capacity: 0.4 A max. at room temp.  
min. switching current: 7.5 mA  
leakage current in off-state: < 3.5 mA constant  
voltage drop: ca. 6 V (2-wire connection)

NWS-...23/24/2W/2H...: connector M12x1, 4-pole or 1.5 m  
fixed cable, 3-pole  
switching output: O. C. PNP or NPN (factory  
set), max. 300 mA, short-circuit-proof  
contact function: N/C or N/O adjustable  
by switching polarity of supply voltage  
(only NWS...23/24)

Overload cut-off (NWS-2x): In case of thermal overload or excessive current,  
the unit cut off the load. The triggering of  
overload protection is indicated by fast blinking of  
the LED.

NWS-...2E.. (ATEX): connector M12x1, 4-pole or 1.5 m cable  
2-wire NAMUR output  
N/C or N/O selectable  
N/C:  $\geq 2.1$  mA discovered  
 $\leq 0.8$  mA covered  
N/O:  $\leq 0.8$  mA discovered  
 $\geq 2.1$  mA covered



## 11. Order Codes

Example: NWS-R20 20 0 0000

Connection	Model	Electrical connection	Sensor version
R ¼ male thread	NWS-R20...	<b>Plastic housing</b> <b>200</b> = 24...240 V <sub>AC/DC</sub> cable gland/terminal connect.  <b>St. steel housing/plug connect.</b> <b>23S</b> = 24 V <sub>DC</sub> , PNP, plug M12x1 <b>24S</b> = 24 V <sub>DC</sub> , NPN, plug M12x1 <b>2WS***</b> = 24 V <sub>DC</sub> , WHG, PNP, plug M12x1 <b>2HS***</b> = 24 V <sub>DC</sub> , WHG, NPN, plug M12x1 <b>2ES</b> = ATEX-approval, plug M12x1  <b>St. Steel housing/cable connect.</b> <b>23F</b> = 24 V <sub>DC</sub> , PNP, 1.5 m cable <b>24F</b> = 24 V <sub>DC</sub> , NPN, 1.5 m cable <b>2WF***</b> = 24 V <sub>DC</sub> , WHG, PNP, 1.5 m cable <b>2HF***</b> = 24 V <sub>DC</sub> , WHG, NPN, 1.5 m cable <b>2EF</b> = ATEX-approval, 1.5 m cable	<b>0060</b> = 60 mm (only for NWS-T / NWS-L / NWS-H)
R 1 male thread	NWS-R25...*		<b>0070</b> = 70 mm standard version, short (not for NWS-T / NWS-L)
¾ NPT male thread	NWS-N20...		<b>0117**</b> = 117 mm extended
1 NPT male thread	NWS-N25...*		<b>0300**</b> = 300 mm sensor
DIN-flange DN 25	NWS-F25...		<b>0500**</b> = 500 mm sensor
DIN-flange DN 50	NWS-F50...*		<b>1000**</b> = 1000 mm sensor
1" ANSI-flange	NWS-A25...		<b>XXXX**</b> = please specify special length 4-position in mm (max. 3000 mm)
2" ANSI-flange	NWS-A50...*		
Tri-Clamp DN 40	NWS-T40...		
Tri-Clamp DN 50	NWS-T50...		
Sanitary DN 40 (DIN 11851)	NWS-L40...		
Sanitary DN 50 (DIN 11851)	NWS-L50...		
Aseptic connection DN 50 (DIN 11864)	NWS-H50...		
DRD Ø 125 mm flange	NWS-D1Z...		
Special connection	NWS-YYY...		

\*\*only models marked with \*are available with sensors in extended version.

\*\*\*WHG-approval in preparation.

## 12. Service and Maintenance

The functional behaviour of these devices is stable, even over long periods or time. Regular adjustments or similar procedures are not required. No maintenance of any type is required.

In the event that device faults are noted, this device should be immediately removed from service. The device contains no user-serviceable parts. Return the device to the manufacturer for examination.

## 13. Trouble Shooting

Devices that are operated in hazardous areas must not be modified in any way. Repairs must be performed by trained, qualified service personnel only. Defective devices should normally be returned to the manufacturer for examination.

## 14. Recommended Spare Parts

---

There are no recommended spare parts.

If the device becomes defective, it usually means that there is a fault in the device electronics that must be diagnosed and repaired.

In this case, we recommend that the device be returned to the manufacturer for servicing.

## 15. Disposal

---

Disposal of packaging and used parts shall be done in conformance with the regulations of the country in which the device is installed.

## 16. Dimensions

NWS-...200  
 24...V<sub>AC/DC</sub>  
 Plastic housing

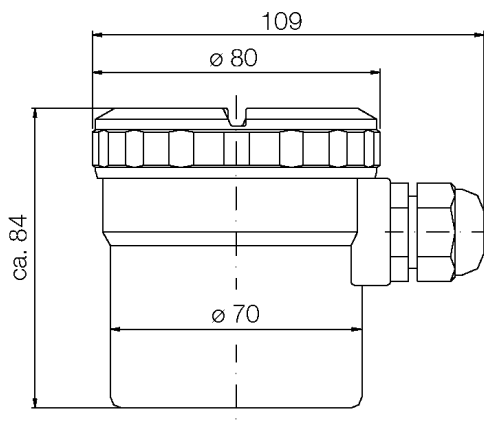

NWS-...23S/24S  
 NWS-...2WS/2HS  
 24 V<sub>DC</sub>  
 Plug connection

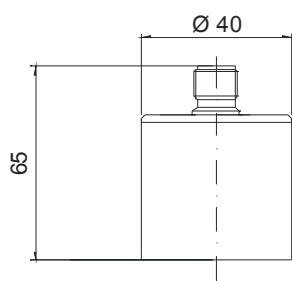

NWS-...23F/24F  
 NWS-...2WF/2HF  
 24 V<sub>DC</sub>  
 Terminal connection

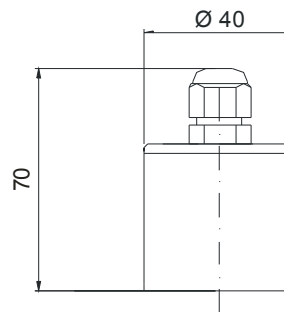

NWS-...2ES  
 ATEX  
 Plug connection

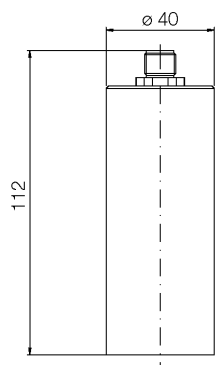

NWS-...2EF  
 ATEX  
 Cable connection

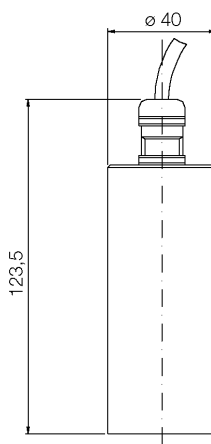

NWS-R20/N20  
(Standard, short)

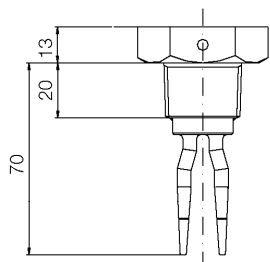

NWS-R25/N25  
NWS-  
N25...0117

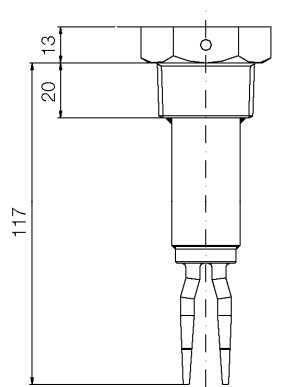

NWS-F../NWS-A..  
Flange version

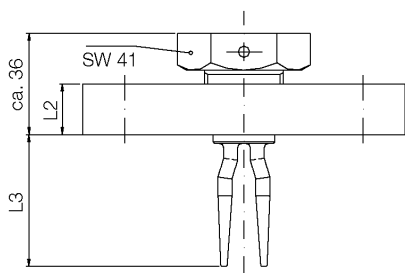

NWS-T..  
Tri-clamp

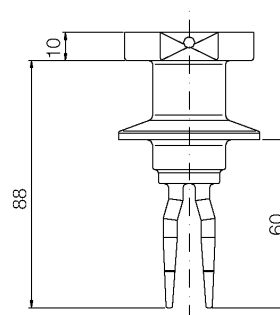

	L2	L3
DN 25 / PN 40	18	approx. 47
DN 50 / PN 40	20	approx. 95
ANSI 1" 300 lbs	17,5	approx. 41
ANSI 2" 300 lbs	22,4	approx. 92

NWS-L..  
Sanitary connection  
(DIN 11851)

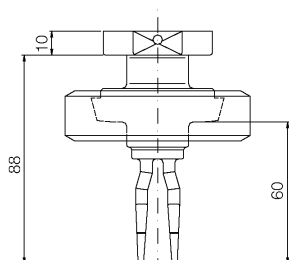

NWS-H..  
Aseptic connection  
(DIN 11864)

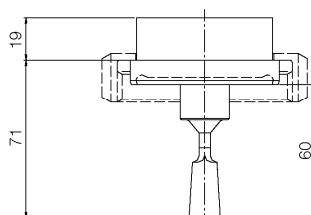

## 17. Declaration of Conformance

---

We, KOBOLD Messring GmbH, Hofheim-Ts, Germany, declare under our sole responsibility that the product:

Level Switch                      model: NWS -..

to which this declaration relates is in conformity with the standards noted below:

**EN 61010-1**                      Safety requirements for electrical equipment for measurement, control and laboratory use 2002

**EN 61326-A2**                      Electrical equipment for measurement, control and laboratory use - EMC requirements, industrial area, 2006

Additional for model **NWS-\*\*\*2E\* \*\*\*\***

EN 60079-0:2012  
EN 60079-11:2012  
EN 60079-26:2007

Also the following EEC guidelines are fulfilled:

**2004/108/ EC** (Electromagnetic compatibility)  
**2006/95/EC** (Low voltage guideline)  
**94/9/EC** Equipment and Protective systems intended for use in a potentially Explosive Atmospheres (ATEX 100a)  
**Quality Management Production**  
Certificate number: BVS 09 ATEX ZQS/E110  
Notified body: DEKRA Exam GmbH  
Identification number: 0158

Hofheim, 30. Jan. 2014



H. Peters  
General Manager

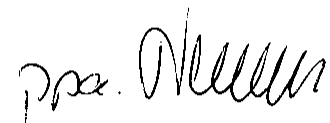

M. Wenzel  
Proxy Holder

# 18. Supplement to the EC-Type Examination certificate



Translation

## (1) 1. Supplement to the EC-Type Examination Certificate

- (2) Equipment and protective systems intended for use in potentially explosive atmospheres - Directive 94/9/EC Supplement accordant with Annex III number 6
- (3) No. of EC-Type Examination Certificate: **BVS 03 ATEX E 119**
- (4) Equipment: **Vibrating fork type NWS-\*\*\*2E\* \*\*\*\***
- (5) Manufacturer: **KOBOLD Messring GmbH**
- (6) Address: **Nordring 22-24, 65719 Hofheim/Ts., Germany**
- (7) The design and construction of this equipment and any acceptable variation thereto are specified in the appendix to this supplement.
- (8) The certification body of DEKRA EXAM GmbH, notified body no. 0158 in accordance with Article 9 of the Directive 94/9/EC of the European Parliament and the Council of 23 March 1994, certifies that this equipment has been found to comply with the Essential Health and Safety Requirements relating to the design and construction of equipment and protective systems intended for use in potentially explosive atmospheres, given in Annex II to the Directive. The examination and test results are recorded in the test and assessment report BVS PP 03.2083 EG.
- (9) The Essential Health and Safety Requirements are assured by compliance with:
  - EN 60079-0:2012 General requirements**
  - EN 60079-11:2012 Intrinsic safety „i“**
  - EN 60079-26:2007 Equipment with equipment protection level (EPL) Ga**
- (10) If the sign "X" is placed after the certificate number, it indicates that the equipment is subject to special conditions for safe use specified in the appendix to this certificate.
- (11) This supplement to the EC-Type Examination Certificate relates only to the design, examination and tests of the specified equipment in accordance to Directive 94/9/EC. Further requirements of the Directive apply to the manufacturing process and supply of this equipment. These are not covered by this certificate.
- (12) The marking of the equipment shall include the following:

 **II 1G Ex ia IIC T6 Ga**

DEKRA EXAM GmbH  
Bochum, dated 7th January 2013

Signed: Hans Christian Simanski

Signed: Dr. Franz Eickhoff

\_\_\_\_\_  
Certification body

\_\_\_\_\_  
Special services unit



- (13) Appendix to
- (14) **1. Supplement to the EC-Type Examination Certificate BVS 03 ATEX E 119**
- (15) 15.1 Subject and type

Vibrating fork type NWS-\*\*\*2E\* \*\*\*\*  
 Instead of the \* in the complete denomination numerals and figures will be inserted which characterize different variations:  
 type NWS-\*\*\*2E\* \*\*\*\*

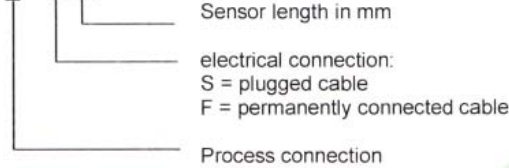

15.2 Description

The vibrating fork is used for measurement of liquid levels. The electrical components of the sensor are completely encapsulated in a metal enclosure. The electrical connection is by a plugged cable (type NWS-\*\*\*2ES \*\*\*\*) or a permanently connected cable (type NWS-\*\*\*2EF \*\*\*\*). The vibrating fork has to be protected from external physical impact.

For use in zone 0, the vibrating fork with plugged cable has to be installed in such a way, that electrostatic charging of the plug and cable can be excluded.

The vibrating fork can also be manufactured according to the documents listed in the test report; the vibrating fork has been slightly modified and assessed in accordance with the new standards.

15.3 Parameters

Maximum input voltage	Ui	DC	20	V
Maximum input current	Ii		100	mA
Maximum input power	Pi		1	W
Effective internal capacitance	Ci		8	nF
Effective internal inductance	Li		negligible	

For the connected cable, the following values have to be additionally regarded:  
 Capacitance per unit length 0,14 nF/m  
 Inductance per unit length 0,65 µH/m

Ambient temperature range	Ta	-40 °C up to +70 °C
---------------------------	----	---------------------

The possible medium temperature and the allocation of the temperature class are shown in the following table:

Temperature class	T6	T5	T4	T3
Max. medium temperature	75 °C	90 °C	125 °C	150 °C

- (16) Test and assessment report  
 BVS PP 03.2083 EG as of 07.01.2013



(17) Special conditions for safe use Installation instructions

None

---

We confirm the correctness of the translation from the German original.  
In the case of arbitration only the German wording shall be valid and binding.

DEKRA EXAM GmbH  
44809 Bochum, 7th January 2013  
BVS-/Le/Ma A 20120463

Certification body

Special services unit



# 19. IECEx Certificate



## IECEx Certificate of Conformity

Certificate No.: **IECEx BVS 13.0004**  
**Annex**  
 Page 1 of 1

### Subject and Type

Vibrating fork type NWS-\*\*\*2E\* \*\*\*\*

Instead of the \* in the complete denomination numerals and figures will be inserted which characterize different variations:

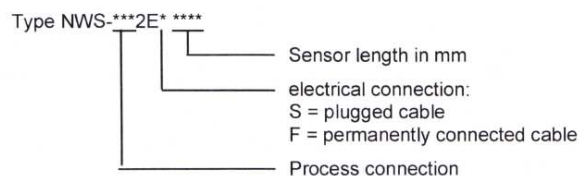

The vibrating fork is used for measurement of liquid levels.  
 The electrical components of the sensor are encapsulated in a metallic enclosure.  
 The electrical connection is by a plugged cable (type NWS-\*\*\*2ES \*\*\*\*) or a permanently connected cable (type NWS-\*\*\*2EF \*\*\*\*).

### Parameters

Maximum input voltage	U <sub>i</sub>	DC	20	V
Maximum input current	I <sub>i</sub>		100	mA
Maximum input power	P <sub>i</sub>		1	W
Effective internal capacitance	C <sub>i</sub>		8	nF
Effective internal inductance	L <sub>i</sub>			negligible

For the connected cable, the following values have to be additionally regarded:

Capacitance per unit length	0.14	nF/m
Inductance per unit length	0.65	μH/m

Ambient temperature range      T<sub>a</sub>                      -40 °C up to +70 °C

The possible medium temperature and the allocation of the temperature class are shown in the following table:

Temperature class	T6	T5	T4	T3
Max. medium temperature	75 °C	90 °C	125 °C	150 °C